



CIVIC MEDIA CO.,LTD  
 2/24-25 Soi Charoenkrung 78 Charoenkrung Road,  
 Bangkholame, Bangkok 10210 Thailand  
 Tel : +662 688-0860 FAX : +662 688-0862  
<http://www.civicmedia.com>



# LED MODULE

## OUTDOOR 16X16 P11mm.

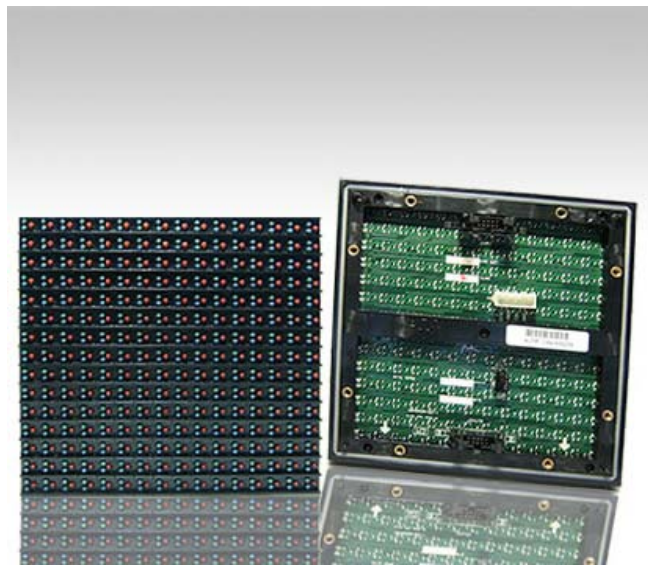

ITEM	DESIGNED	INSPECTOR	APPROVED
SIGNATURE	<i>A. Ward</i>	<i>[Signature]</i>	<i>[Signature]</i>
DATE	2008/12/23	2008/12/23	2008/12/23

1.LED MODULE NAME : OUTDOOR 16X16 P11mm.

## 2.FEATURES

ITEM		DESCRIPTION
DISPLAY COLOR		Full Color(Red+Green+Blue)
WEIGHT		500(g)
DRIVE MODE		1/4 DUTY DRIVE
APPLICATION		OUTDOOR
STRUCTURE	SIZE(WxHxD)	176x176x23(mm)
	DOT PITCH	11(mm)
	NUMBER OF DOTS	256 (16x16)DOTs
	LED PER DOT	Red+Green+Blue

## 3.ABSOLUTE MAXIMUM RATINGS

ITEM	SYMBOL	VALUE	UNIT	REMARK
OPERATING TEMPERATURE	$T_{op}$	-40 ~ 60	°C	
STORAGE TEMPERATURE	$T_{stg}$	-40 ~ 80	°C	
SUPPLY VOLTAGE	$V_{cc}$	0 ~ +5.5	V	
SIGNAL INPUT VOLTAGE LEVEL	$V_{iH}, V_{iL}$	-0.4 ~ $V_{cc}+0.4$	V	

## 4.RECOMMENDED OPERATING CONDITIONS

ITEM		SYMBOL	MIN.	TYP.	MAX.	UNIT	REMARK
SUPPLY VOLTAGE	LED & LOGIC CIRCUIT	$V_{cc}$	4.75	5	5.25	V	
SIGNAL INPUT VOLTAGE LEVEL		$V_{iH}$	$0.7 \times V_{cc}$	-	$V_{cc}$		
		$V_{iL}$	0	-	$0.3 \times V_{cc}$		
OPERATING TEMPERATURE		$T_{op}$	0 ~ 60			°C	

## 5. ELECTRICAL CHARACTERISTICS (AT $T_a = 25^\circ\text{C}$ )

ITEM	SYMBOL	VALUE	UNIT	REMARK
CLOCK FREQUENCY	F	15	MHz	
CURRENT CONSUMPTION PER MODULE	$I_{cc}$	3.5	A	ALL ON

	LED MODULE	REV.NO	DATE	PAGE
	OUTDOOR P11mm.	0	2008.12.23	1/5

## 6. OPTICAL CHARACTERISTICS (AT Ta = 25°C)

ITEM		SYMBOL	MIN.	TYP.	MAX.	UNIT	REMARK
BRIGHTNESS	RED	$L_v$	-	1400	-	$cd/m^2$	
	GREEN		-	1700	-		
	BLUE		-	650	-		
	WHITE		-	3800	-		
WAVELENGTH	RED	$\lambda_p$		630		nm	
	GREEN			525			
	BLUE			470			
VIEWING ANGLE	HOR.	Angle		40		deg(°)	
	VER.			40			

## 7. SIGNAL FUNCTION

### 1) DATA SIGNAL CONNECTOR

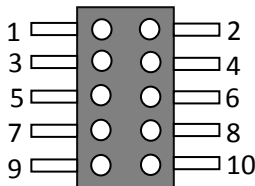
Pin Map (IN)	Pin Number	Pin Name	Function Description
	1	Red	Data Input Red Color
	2	Green	Data Input Green Color
	3	Blue	Data Input Blue Color
	4,6	GND	Ground of the Module
	5	Clock	Shift Clock for Input Data
	7	Latch	Data Strobe
	8	A	2 bit line Address
	10	B	
	9	OE	Brightness Control

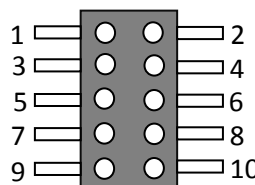
Pin Map (OUT)	Pin Number	Pin Name	Function Description
	1	Red_Out	Data Output Red Color
	2	Green_Out	Data Output Green Color
	3	Blue_Out	Data Output Blue Color
	4,6	GND	Ground of the Module
	5	Clock_Out	Shift Clock for Output Data
	7	Latch_Out	Data Strobe
	8	A_Out	2 bit line Address
	10	B_Out	
	9	OE_Out	Brightness Control

## 2) POWER CONNECTOR

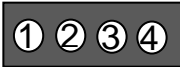
Pin Map (Power)	Pin Number	Pin Name	Function Description
	1	VLED	Supply Voltage for LED& Module
	2	GND	Ground of Module
	3	VCC	Supply Voltage for LED& Module
	4	GND	Ground of Module

## 3) CONNECTOR SPECIFICATION

ITEM	VENDOR	MODUL NO.	SPECIFICATION	HOUSING MODEL NO.
DATA CON	GTK	SCP10GS11	10Pin P2.54mm.	SC10TA11
POWER CON	GTK	111404ST	4Pin P5.08mm.	-

	LED MODULE	REV.NO	DATE	PAGE
	OUTDOOR P11mm.	0	2008.12.23	3/5

## 8. BLOCK DIAGRAM

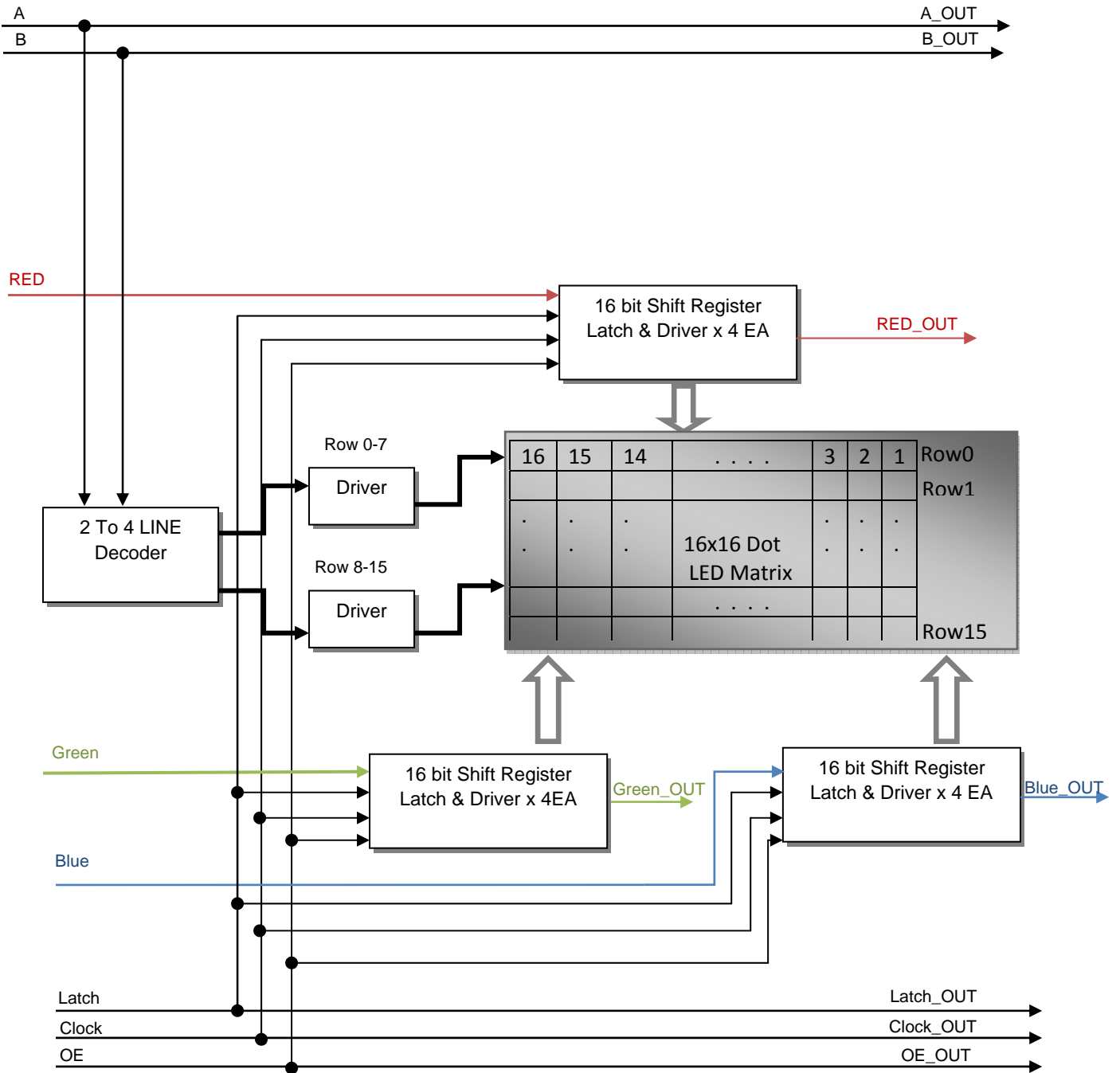

	LED MODULE	REV.NO	DATE	PAGE
	OUTDOOR P11mm.	0	2008.12.23	4/5

## 9. DIMENSION

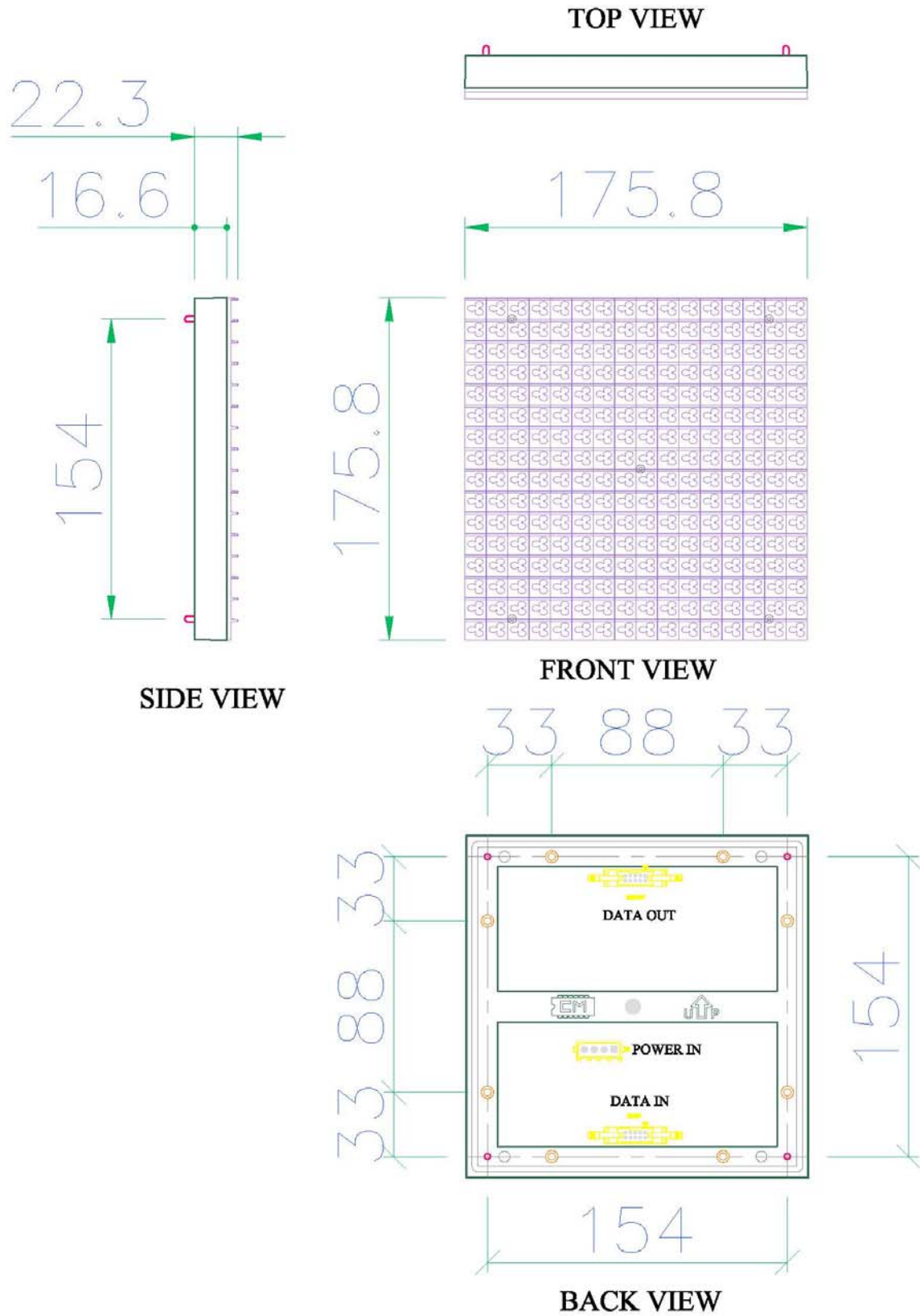

	LED MODULE	REV.NO	DATE	PAGE
	OUTDOOR P11mm.	0	2008.12.23	5/5